

- Check out Casters, Glides & Levelers
- Check out Cabinet Hinges

Handing Chart

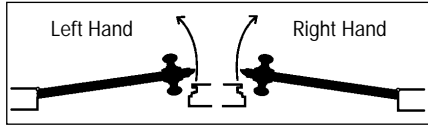

LCN Closers—High strength cast iron cylinder

- All weather fluid eliminates seasonal adjustments for temperatures ranging from 120°F (49°C) to -30°F (-35°C). **4030 & 4130** closers are restricted to interior doors and operate through a temperature range of 120°F (49°C) to 0°F (-18°C).

LCN 1460 Surface Mount

- Use on narrow head frames (1¾") and top rails.
- Standard closer shipped with regular arm (non-hold-open), a slim line non-metallic cover, and wood and machine screw pack.
- Meets ADA requirements.
- Exterior doors to 48", Interior doors to 60"
- Non-Handed
- Double lever arm

Pull side dimensions

- Projection: Arm 11¾", Cover 2¾" D
- Cover dim.: 12¼"W x 2"H

Item	Price each	
	1-5	6+
1461-Alum	\$175.00	Call



LCN 4040 Surface Mount

The double lever arm is designed for interior doors to 60"W & exterior doors to 48". The modern appearance and smooth performance make this the ideal closer for institutional and other high traffic applications.

- Non-handed
- Meets ADA requirements.
- Shipped with regular arm (non-hold-open), standard non-metallic cover and wood and machine screw pack.
- Mounts hinge side, top jamb
- SRI primer for installations in corrosive conditions.

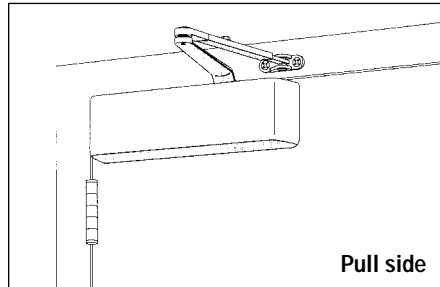

Pull side

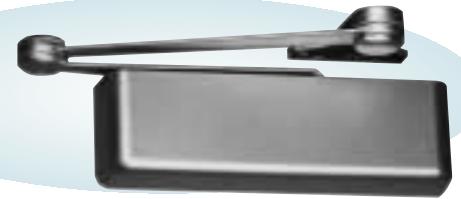

Pull side dimensions

- Projection: Arm 11", Base 2¼"
- Cover dimensions: 12¼"W x 3½"H

Item	Price each	
	1-5	6+
4041-Alum	\$226.00	Call

Norton 8501

- Multi-Size Power: The closer spring assembly can be adjusted through a wide power range. A high shoulder adjustment nut accepts a standard ⅝" socket or wrench.
- Non-handed: Pinion shaft extends vertically through the closer body in both directions. This permits the closer to be positioned on either right or left hand doors for all application.
- Adjustable sweep speed.
- Adjustable Backcheck Cushioning.
- Adjustable delayed action closing.
- Molded full cover.
- Non-Hold-Open Arm: Standard closer will be supplied with a Non-Hold-Open arm. This arm is non-handed.



Pull side dimensions

- Projection: Base 2⅝"
- Cover dimensions: 13"W x 2⅞"H

Finish	Item	Price each	
		1-9	10+
Brass	NO8501M3	189.00	174.00

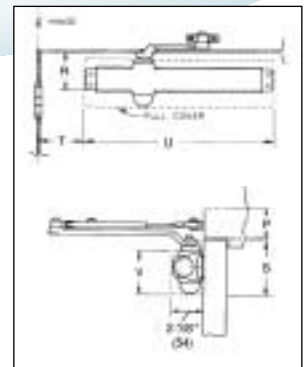

LCN 3130 Completely Concealed

- Single lever arm and roller assembly provides complete concealment
- Designed to mount in a 1¾" interior door.
- Sized cylinders for interior doors up to 38"
- Closer shipped with standard arm, regular track (non-hold-open) and wood and machine screw pack
- Handed for right or left swinging door.
- **Butt Hinges** should not exceed 5" (127mm) in width.

- **Auxiliary Stop** is recommended at hold-open point or where a door cannot swing 140°. Optional track bumper assembly assists backcheck in cushioning the opening swing of the door. It is not intended to replace an auxiliary stop.
- **Top Rail** minimum 4" (102mm) required.
- **Door Thickness** 1¾" (44mm) minimum
- **Door Width** 2'2" (660mm) minimum

Pull side dimensions

- Projection: Arm 0"
- Cover dimensions: 8¾"W x 3"H



Hand	Item	Price each	
		1-5	6+
Left	LC3133LA	\$224.00	Call
Right	LC3133RA	224.00	Call



450S Series-Surface Overhead Door Holder

- Medium to light-duty applications.
- Single acting doors
- Interior/exterior applications
- Reversible, non-handed.
- Stop-only models offer a smooth and rugged shock absorbing mechanism designed to protect doors & door frames.
- Incorporates popular channel/slide arm design and offset jamb brackets for improved compatibility with many door closers.
- Improved design allows for simple field changing of functions to compensate for changes in user requirements.

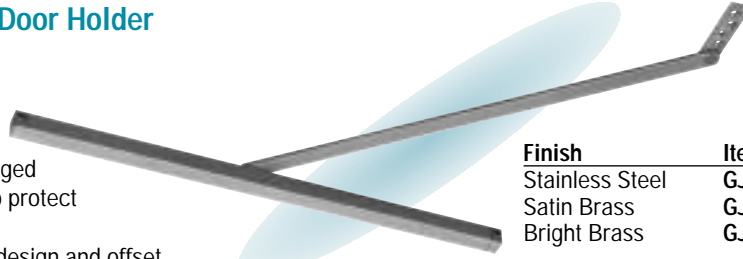

Finish	Items	Price Each
Stainless Steel	GJ452S-US32D	80.80
Satin Brass	GJ452S-US4	84.80
Bright Brass	GJ452S-US3	96.80
Stainless Steel	GJ453S-US32D	80.80
Satin Brass	GJ453S-US4	84.80
Bright Brass	GJ453S-US3	96.80
Stainless Steel	GJ454S-US32D	80.80
Satin Brass	GJ454S-US4	84.80
Bright Brass	GJ454S-US3	96.80

Included with each series above
Friction Kit GJ400FK
Hold-Open Kit GJ400HK

450 Series Sizing Chart

Size	Butts/Offset Pivots	Center Pivot
452	18"-23"	23 ¹ / ₁₆ "-27"
453	27 ¹ / ₁₆ "-33"	33 ¹ / ₁₆ "-39"
454	33 ¹ / ₁₆ "-39"	39 ¹ / ₁₆ "-45"

RIXSON® 28 Series

Center Hung Floor Closers for doors to 300 lbs

- Exterior or interior doors. Not allowed for labeled fire doors.
- For doors up to 4'0"W x 8'6"H.
- Single acting and handed.
- Dull chrome finish
- A frame applied stop at 0° must be used to prevent closer from closing beyond 0°.
- Selective hold-open at 90°. (For selective hold-open at 85°, 95°, or 105°, call our technical department.)
- Built-in positive dead stop prevents door from swinging beyond the desired opening degree.
- Cyclocac cement case.
- Separate valves for closing, latch and back check adjustments.
- Vertical door adjustment. Adjustable spring tension.

340 Center Hung Top Pivot

- Included with 28 Closer. Full mortise—Non-handed.
- A top pivot is an integral part of the pivot set. Special top pivot may be required when special door or frame conditions are present (please call technical for questions).
- Walking beam-type pivot.
1/2" diameter pivot pin with 3/4" engagement.
- Oil impregnated sintered bronze bearing.
- Completely concealed when door is closed.

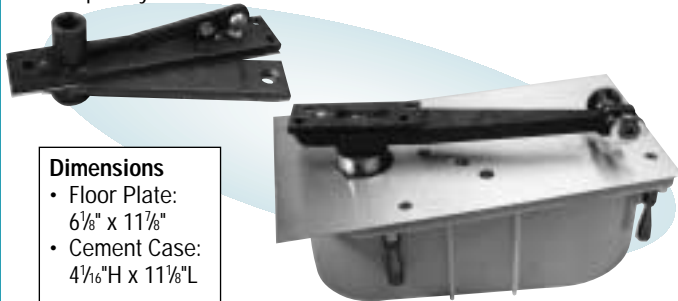

Dimensions

- Floor Plate:
6¹/₈" x 11⁷/₈"
- Cement Case:
4¹/₁₆"H x 11¹/₈"L

Hand	Finish	Item
Left	Dull Chrome	RX28LHSHO26D
Right	Dull Chrome	RX28RHSHO26D
Left	Pol. Brass	RX28LHSHO3
Right	Pol. Brass	RX28RHSHO3

Call For Pricing
And Additional Specs

RIXSON® 27 Series

3/4" Offset Hung Floor Closers for doors to 450 lbs

- Exterior or interior doors.
- For doors up to 48"W x 8'6"H. Door edges must be beveled 1/8" in 2"
- Single acting and handed.
- Dull chrome finish
- 3/4" offset floor closers locate the pivot point 3/4" from the heel edge of the door and 3/4" from the face of the door.
- Frame doorstop must be provided at door closed position.
- Cyclocac cement case.
- Separate valves for closing, latch and back check adjustments.
- Built-in positive dead stop prevents door from swinging beyond the desired opening degree.
- Vertical door adjustment. Adjustable spring tension.

180 Top Pivot

- Included with 27-3/4 Closer. Full mortise—non-handed.
- A top pivot is an integral part of the pivot set. Special top pivot may be required when special door or frame conditions are present (please call technical for questions).
- Oil impregnated sintered bronze bearing.

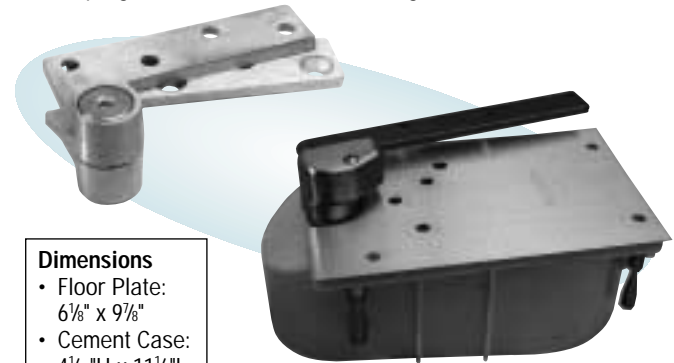

Dimensions

- Floor Plate:
6¹/₈" x 9⁷/₈"
- Cement Case:
4¹/₁₆"H x 11¹/₈"L

Hand	Finish	Item
Left	Dull Chrome	RX27LHSHO26D
Right	Dull Chrome	RX27RHSHO26D
Left	Pol. Brass	RX27LHSHO3
Right	Pol. Brass	RX27RHSHO3

- Check out **Sliding Door Hardware**
- Check out **Production & Finishing Materials**

VON DUPRIN

22 Fire Exit Rim Device

Rim device for all types of single and double doors with mullion, UL listed for accident hazard installations. Covers stock hollow metal doors with 161 (2 $\frac{1}{8}$ " cutouts.

Fits doors 30"W to 36"W.

Fits door stiles as narrow as 3 $\frac{3}{16}$ "

Features:

- Non-handed
- Field sizeable
- $\frac{3}{4}$ " (19mm) throw latch bolt
- Latch bolt deadlocking
- Hex key dogging



36" Panic Device

Sprayed Aluminum

Item	1-9	10+
VD22E0US28	\$211.95	\$189.99

Knob Handle

Sprayed Aluminum. 10 gauge steel escutcheon with a Schlage "A"-series orbit knob with six pin "C" keyway.

Item	1-9	10+
VD210KUS28	\$85.17	\$81.60



Lever Handle

Sprayed Aluminum. $\frac{3}{4}$ " deep cast aluminum escutcheon. Rim cylinder must be ordered separately.

Rim cylinder
SC20022626 \$18.00

Item	1-9	10+
VD230LUS28	\$83.40	\$79.90

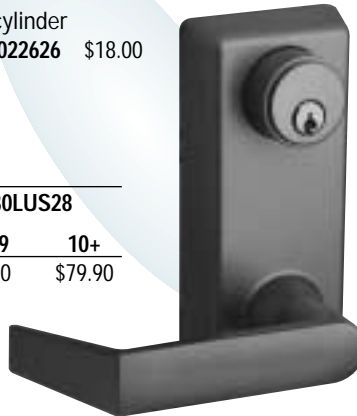

Pull Plate

Sprayed Aluminum.
Rim cylinder must be ordered separately.
Rim cylinder SC20022626 \$18.00



Item	1-9	10+
VD210NLUS28	\$25.55	\$24.48

Thumb Piece Handle

Sprayed Aluminum.
10 gauge steel escutcheon.
Rim cylinder must be ordered separately.

Rim cylinder
SC20022626 \$18.00

Item	1-9	10+
VD230TPUS28	\$108.55	\$104.00



We are an official Von Duprin Distributor.

If you don't see
what your looking for,
please call 718-726-8000