



Flush Pulls- Low profile for sliding, bi-fold and pocket doors.

Heavy Duty Pull

- Size 1⁵/₁₆" x 3¹/₈" x 7¹/₁₆"
- Two piece construction
- Includes screws.



Price each

Finish	Item	1-9	10-19	20+
Chrome	222B26	\$16.05	\$14.85	Call
Satin Chr.	222B26D	16.05	14.85	Call
Brass	222B3	16.05	14.85	Call

Oblong Pull

- Size 3¹/₁₆" x 1¹/₁₆" x 1¹/₂"
- Includes screws.



Price each

Finish	Item	1-9	10-19	20+
Chrome	223B26	\$4.78	\$4.30	Call
Satin Chr.	223B26D	4.78	4.30	Call
Brass	223B3	4.78	4.30	Call

Contoured Grip

- Size 3³/₈" x 1³/₄" x 5¹/₁₆"
- Includes screws.



Price each

Finish	Item	1-9	10-19	20
Chrome	227B26	\$7.40	\$6.66	Call
Satin Chr.	227B26D	7.40	6.66	Call
Brass	227B3	7.40	6.66	Call

Reverse Tapered Grip

- Size 1⁵/₁₆" x 3¹/₈" x 7¹/₁₆"
- Includes screws.



Price each

Finish	Item	1-9	10-19	20+
Chrome	22B26	\$2.38	\$2.14	Call
Satin Chr.	22B26D	2.38	2.14	Call
Brass	22B3	2.38	2.14	Call

Pull with Built-In Prongs

- Built-in prong design eliminates the need for screws or brads
- Packed with two escutcheon pins for added holding power.
- Cup depth 7¹/₁₆"

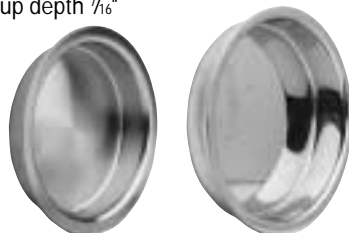

Finish	Cup Overall		Item	Price each		
	Dia.	Dia.		1-9	10-19	20+
Satin Chr.	2"	2 ⁵ / ₁₆ "	220B26D	\$2.87	\$2.58	Call
Satin Chr.	2 ¹ / ₈ "	2 ⁷ / ₁₆ "	221B26D	2.87	2.58	Call
Brass	2 ¹ / ₈ "	2 ⁷ / ₁₆ "	221B3	2.87	2.58	Call

Pull with Brads or Screws

- 225 cup depth 3³/₈", includes brads.
- 226 cup depth 7¹/₁₆", includes screws.

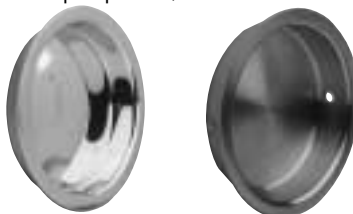

Finish	Cup Overall		Item	Price each		
	Dia.	Dia.		1-9	10-19	20+
Satin Brnz	1 ¹ / ₂ "	1 ³ / ₄ "	225B10	\$3.10	2.79	Call
Chrome	1 ¹ / ₂ "	1 ³ / ₄ "	225B26	3.10	2.79	Call
Satin Chr.	1 ¹ / ₂ "	1 ³ / ₄ "	225B26D	3.10	2.79	Call
Brass	1 ¹ / ₂ "	1 ³ / ₄ "	225B3	3.10	2.79	Call
Chrome	2 ¹ / ₈ "	2 ¹ / ₂ "	226B26	5.02	4.52	Call
Satin Chr.	2 ¹ / ₈ "	2 ¹ / ₂ "	226B26D	5.02	4.52	Call
Brass	2 ¹ / ₈ "	2 ¹ / ₂ "	226B3	5.02	4.52	Call

Pull with Ring

- For use on bi-fold doors
- 425 cup depth 3³/₈"
- 426 cup depth 7¹/₁₆"
- Includes screws



Finish	Cup Overall		Item	Price each		
	Dia.	Dia.		1-9	10-19	20+
Chrome	1 ¹ / ₂ "	1 ³ / ₄ "	425B26	\$7.28	\$6.55	Call
Satin Chr.	1 ¹ / ₂ "	1 ³ / ₄ "	425B26D	7.28	6.55	Call
Brass	1 ¹ / ₂ "	1 ³ / ₄ "	425B3	7.28	6.55	Call
Chrome	2 ¹ / ₈ "	2 ¹ / ₂ "	426B26	9.26	8.33	Call
Satin Chr.	2 ¹ / ₈ "	2 ¹ / ₂ "	426B26D	9.26	8.33	Call
Brass	2 ¹ / ₈ "	2 ¹ / ₂ "	426B3	9.26	8.33	Call

Sliding Door Lock

- Fits doors 1³/₈" to 1¹/₂" thick
- Universal handing
- Includes mounting hardware



Finish	Item	Price each		
		1-9	10-19	20+
Brass	991B3	\$14.73	\$13.26	Call
Chrome	991B26	14.73	13.26	Call

Sliding Door Edge Pull

- The 3³/₄" width allows installation on narrow, as well as standard doors.
- Spring automatically returns lever flush with plate.
- Size 3⁷/₈" x 3³/₄" x 1⁵/₁₆"
- Includes screws.



Finish	Item	Price each		
		1-9	10-19	20+
Chrome	230B26	\$10.36	\$9.32	Call
Satin Chr.	230B26D	10.36	9.32	Call
Brass	230B3	10.36	9.32	Call

Pocket Sliding Door Bolt

- Emergency release of bolt from outside the door.
- Easily secures pocket sliding doors.
- Spring activated design allows feather-touch action.
- Brass grommet supplied to cap release hole, protecting the door's finish.
- Size of strike 1" x 3³/₄"
- Depth of mortise 5¹/₈"
- Overall size plate: 3¹/₁₆" x 1¹/₈"
- Includes screws, grommet and template.

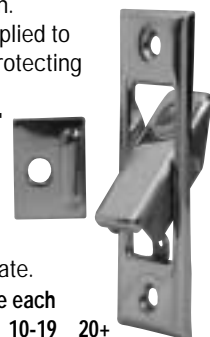

Finish	Item	Price each		
		1-9	10-19	20+
Brass	42B3	\$8.66	\$7.79	Call

- Check out **Functional Cabinet Hardware**
- Check out **Storage & Convenience**

Edge Pull

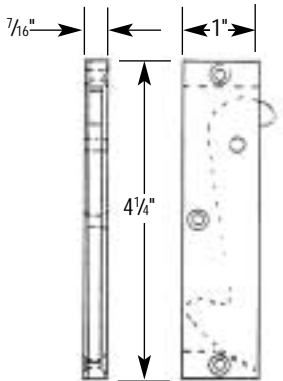

Finish	Item	1-9	10-19	20+
Polished Chrome	RJ158US261	\$47.50	\$38.00	Call
Dull Chrome	RJ158US26D1	47.50	38.00	Call
Polished Brass	RJ158US31	47.50	38.00	Call
Dull Brass	RJ158US41	47.50	38.00	Call

Other Finishes & Sizes Available for Special Order

Extension Flush Bolt For Installations Not Requiring U.L. Label

- Use as top and bottom flush bolts to secure the inactive leaf of a pair of swinging non-fire doors where a U.L. Label is not required.
- Simplified installation in metal frames - round bolt head requires only a punched hole. Use of strike optional. Special design of guide and flat side on bolt head prevent bolt from turning.
- Standard length of rod is 12". Call for additional lengths.
- Rod backset 5/8"
- Square bolt head 1/2"
- Throw 3/4"
- Includes template, installation instructions, machine and wood screws.

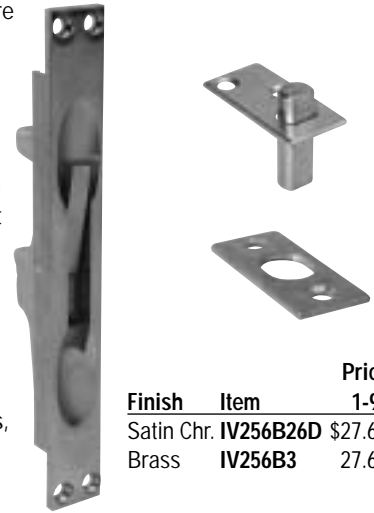

Finish	Item	Price each	
		1-9	10+
Satin Chr.	IV256B26D	\$27.63	Call
Brass	IV256B3	27.63	Call

Extension Flush Bolts For Labeled Metal Doors.

457 & 458 for use as top and bottom flush bolts to secure the inactive leaf of a pair of swinging fire doors, with the active door provided with a listed single point latch.

- **457 & 458** brass only is U.L. Listed for use in hollow metal, metal clad, steel-covered composite, and sheet metal fire doors
- Standard length of rod is 12". Call for additional lengths.
- Rod backset 3/4"
- Dia. of bolt head 1/2"
- Throw 3/4"
- Includes template, installation instructions, machine and wood screws.

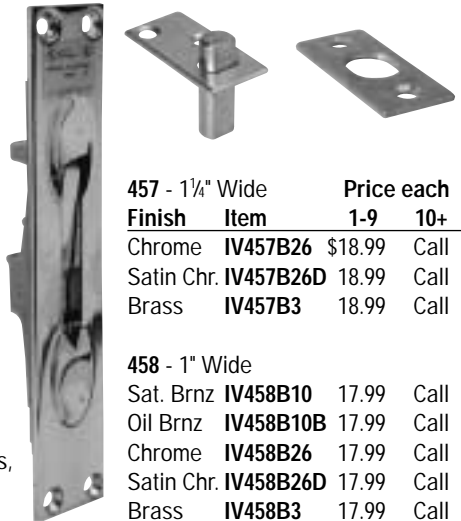

Finish	Item	Price each	
		1-9	10+
Chrome	IV457B26	\$18.99	Call
Satin Chr.	IV457B26D	18.99	Call
Brass	IV457B3	18.99	Call

Finish	Item	Price each	
		1-9	10+
Sat. Brnz	IV458B10	17.99	Call
Oil Brnz	IV458B10B	17.99	Call
Chrome	IV458B26	17.99	Call
Satin Chr.	IV458B26D	17.99	Call
Brass	IV458B3	17.99	Call

Brass Flush Ring Pulls

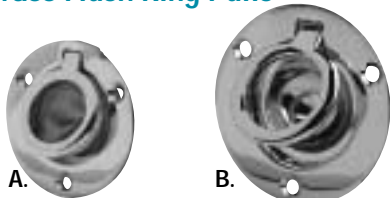

A. Plate Dia.: 1/2" - Inside Ring Dia.: 5/8"
Price each

Finish	Item	1-19	20+
Pol. Brass	0390-030	\$16.20	Call
Satin Chrome	0390-264	16.20	Call
Pol. Chrome	0390-260	16.20	Call

B. Plate Dia.: 1 1/2" - Inside Ring Dia.: 3/4"
Price each

Finish	Item	1-19	20+
Pol. Brass	0391-030	\$16.20	Call
Satin Chrome	0391-264	16.20	Call
Pol. Chrome	0391-260	16.20	Call

Brass Flush Ring Pulls

- Solid forged construction for maximum strength and durability.
- Flush ring pulls are recommended for marine use and where flush installation is essential.

A. Plate Dim.: 1 1/2" x 2 1/2" - Inside Ring Dia.: 1"
Price each

Finish	Item	1-19	20+
Polished Brass	0394-030	\$22.10	Call

B. Plate Dim.: 3 1/2" x 3 1/2" - Inside Ring Dia.: 1 3/4"
Price each

Finish	Item	1-19	20+
Polished Brass	0397-030	\$97.30	Call

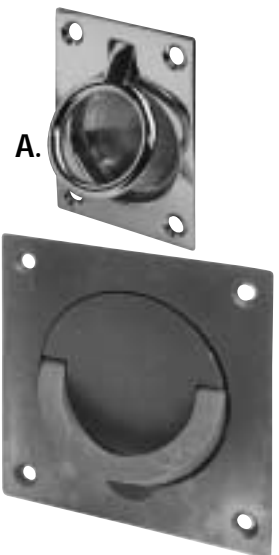



Dust Proof Strikes for Flush Bolts

- **487** Includes screws and lead shields.
- **488** and **489** engineered design provides positive closing action and eliminates binding.
- **488** can be locked in up position, by rotating plunger with screwdriver or coin. Eliminates trapping of spike heels.
- **489** is recommended for use with self-latching and automatic flush bolts or panic bolts. Will not lock-up or down.
- **488** and **489** accommodate thresholds up to 1/4" thick.



488

489

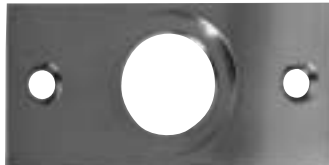

487

Finish	Item	Price each	
		1-9	10+
Satin Chr.	487B26D*	\$8.98	Call
Satin Chr.	488B26D	16.71	Call
Satin Chr.	489B26D	16.71	Call
Brass	489B3	16.71	Call

* Plate & strike sold separately

Barrel Bolts

- The ultimate in simplicity, strength and security; further enhanced by crisp and contemporary styling.
- Steel with zinc plating.
- Non-Handed.
- Bolt dia. 5/16"
- Overall width 1 1/4"
- Projection 1 5/32"
- Throw 5/8"

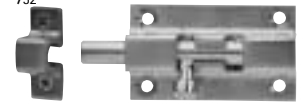

Strike

- Surface strike insures easy mounting on any door trim condition.

Lgth.	Item	Price each	
		1-9	10+
2"	FE90ZP2	\$1.28	Call
3"	FE90ZP3	1.47	Call

Concealed Screw Surface Bolt

- Concealed screws.
- Permanent stop locks rod to track.
- Tension spring holds bolt in desired position.
- Decorative knob.
- Width 5/8"
- Projection 3/4"
- Includes both universal and mortise strikes and screws.

Lgth.	Throw	Finish	Item	Price each	
				1-9	10+
2"	7/16"	Chrome	40B26-02	\$11.48	Call
2"	7/16"	Satin Chr.	40B26D-02	11.48	Call
2"	7/16"	Brass	40B3-02	11.48	Call
2"	7/16"	Sat. Alum	40PA28-2	11.48	Call
3"	1 1/16"	Chrome	40B26-03	11.48	Call
3"	1 1/16"	Brass	40B3-03	11.48	Call
3"	1 1/16"	Sat. Alum	40PA28-03	11.48	Call
4"	1 5/16"	Chrome	40B26-04	12.69	Call
4"	1 5/16"	Satin Chr.	40B26D-04	12.69	Call
4"	1 5/16"	Brass	40B3-04	12.69	Call
6"	1 5/16"	Satin Chr.	40B26D-06	14.75	Call
6"	1 5/16"	Brass	40B3-06	14.75	Call
9"	1 5/16"	Satin Chr.	40B26-09	14.75	Call

Flush Bolt

- Exceptionally smooth working
- Double action spring design provides automatic holding of brass bolt in projected or retracted position, and assures ease of operation in conjunction with deep cup finger hole.
- Rod Backset 1 5/32"
- Dia. of bolt head 1/2"
- Throw 1"
- Includes screws.



Finish	Item	Price each	
		1-9	10+
Satin Chr.	262B26D	\$20.86	Call
Brass	262B3	20.86	Call

Barrel Bolts

- The ultimate in simplicity, strength and security; further enhanced by crisp and contemporary styling.
- Solid brass construction
- Non-Handed.
- Bolt dia. 5/16"
- Overall width 1 1/4"
- Projection 1 5/32"
- Throw 5/8"

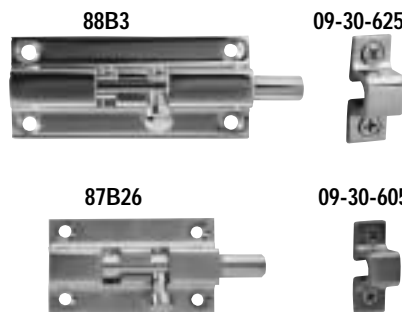

Lgth.	Finish	Item	Price each	
			1-19	20+
2 1/4"	Pol. Chr.	87B26	\$16.28	\$14.80
3"	Brass	88B3	14.34	13.04
STRIKE				
-	Pol. Chr.	09-30-605	5.75 each	
-	Brass	09-30-625	5.75 each	

Flush Bolt

- Deep cup provides good finger hold, allows easy operation.
- Brass bolt automatically held in projected or retracted position by unique spring design.
- Rod Backset 1 5/32"
- Dia. of bolt head 5/16"
- Throw 3/4"
- Includes screws

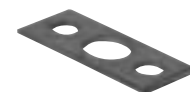

Finish	Item	Price each	
		1-9	10+
Satin Chr.	261B26D	\$14.47	Call
Brass	261B3	14.47	Call

Push Latches

- For secret panels, doors and cabinets.
- Push action opens and closes doors.
- Use where concealed hardware is desired.
- Eliminates need for pulls or knobs; enhances styling and clean appearance of fine furniture and cabinets.
- Simple installation; surface mounted, no mortising required.
- Narrow case design for low profile.

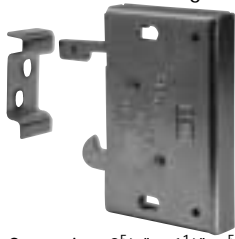

A. Case size: 2⁵/₁₆" x 1¹/₂" x ⁵/₁₆"

- Steel Construction, Heavy gauge parts.
- Includes installation instructions, template and screws.

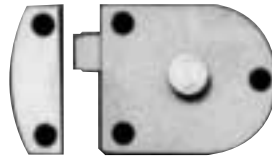

B. Case size: 2" x 2³/₈"
Strike size: 2" x 2³/₄"

Finish	Item	Price each	
		1-19	20+
A. Zinc Plated	820F2C	\$4.60	Call
A. Brass Plated	820F3	4.60	Call
B. Satin Chrome	602-US26D	26.00	Call

Invisible Latches

- AA latch ideal for cabinet doors, small panels, or light doors.
- Solid Brass
 - Case size: 2¹/₄"Hx1¹/₄"Dx⁹/₁₆"W



Invisible Latches

- Larger BB unit is recommended for use on larger panels or light doors.
- Solid Brass
 - Case size: 2¹/₄"Hx1¹/₄"Dx⁹/₁₆"W

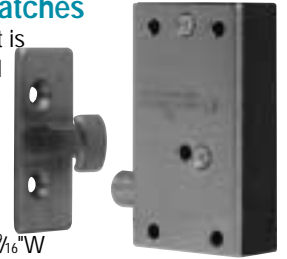

Auxiliary Pusher

- Used in conjunction with AA or BB, where hinges or surrounding conditions require additional opening power. 3" O.A.

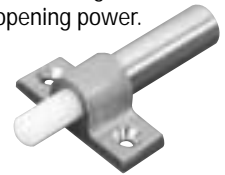

Please Call
718-726-8000
for Pricing and Finishes

Brass Surface Bolt

- Stainless steel tension spring prevents rod disengagement from guide and holds bolt in desired position.
- Half round rod ³/₈"
- Overall width 1³/₁₆"
- Projection ³/₄"
- Includes both universal and angle strikes and screws.

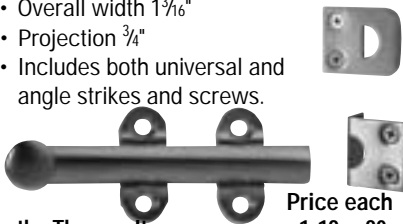

Lgth.	Throw	Item	Price each	
6"	³ / ₄ "	043B26D-6"	1-19	20+
			\$13.46	Call

Dull chrome finish

Many other sizes and finishes are available.

Transom Chain

- Plate 1¹/₂" x 1"
- Includes screws.

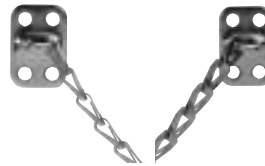

Chain Length	Finish	Item	Price each	
			1-19	20+
12"	Nickel	82F14-12	\$5.46	Call
12"	Brass	82F3-12	5.46	Call

Silencer

- For metal or wood door frames.



Frame	Item	Price per 100	
		100-900	1000+
Metal	GJ64	\$12.99	Call
Wood	GJ65	14.99	Call

Mighty-Mite® Heavy Duty Magnetic Catch

- Load capacity 9 lb.
- Self-aligning magnets insure max. pull.
- Can be surface mounted or mortised.
- Dual double pole.
- Includes instructions, sheet metal screws and one long & two short strikes.
- Case size: 3¹/₈" x 1" x ⁹/₁₆"
- Aluminum



Finish	Item	Price each	
		1-19	20+
Brass	326A3	\$5.88	Call
Natural	326A92	5.88	Call

Super-Mite® Heavy Duty Magnetic Catch

- Load capacity 14 lb.
- Self-aligning magnets insure max. pull.
- Can be surface mounted or mortised.
- Dual double pole.
- Includes instructions, sheet metal screws and one long & two short strikes.
- Case size: 3¹/₈" x 1" x ³/₄"
- Aluminum



Finish	Item	Price each	
		1-19	20+
Brass	327A3	\$10.34	Call
Natural	327A92	10.34	Call

One-Way Viewer (Wide Angle)

- Lens projects ¹/₄" from face of door.
- 4 optical glass lenses.
- Solid brass body and barrel.
- 190° one way vision
- Simple installation—requires only a ⁹/₁₆" hole.
- Door thickness 1³/₈" x 2¹/₈"



Finish	Item	Price each	
		1-19	20+
Brass	698B3	\$14.23	Call



Roller Latch

- Fits heavy duty cylindrical lock mortise.
- Silent nylon roller with 2 3/4" x 1 1/8" strike.
- Knurled nut on back of latch provides easy adjustment of roller projection.
- Includes screws.

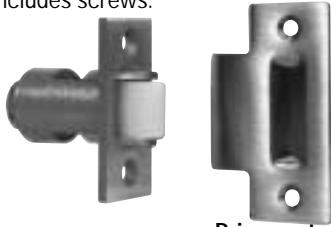

Price each

Finish	Item	1-9	10-19	20+
Stainless	3GJ32US32D	\$66.00	\$59.40	Call
Brass	3GJ32US3	66.00	59.40	Call

Roller Latch

- Silent nylon roller with 2 1/4" x 1 1/8" strike.
- Projection of roller is easily adjusted by way of adjusting screws on face of unit.
- Includes screws.

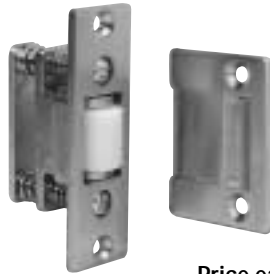

Price each

Finish	Item	1-9	10-19	20+
Chrome	GJ30US26	\$49.00	\$44.10	Call
Satin Chrome	GJ30US26D	49.00	44.10	Call
Brass	GJ30US3	49.00	44.10	Call

Ball Type Latch

- Ideal for holding closet doors, access doors, hook enters only from either side, front or back.

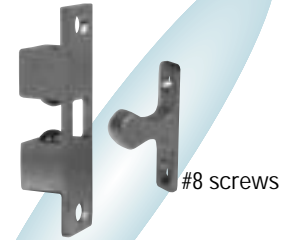

#8 screws

Hook is 1 3/4" H Price each

Finish	Item	1-9	20+
Satin Chr.	GJ21AUS26D	\$28.43	Call
Brass	GJ21AUS3	28.43	Call

Roller Catch 333 Series

- For cabinet and interior doors.
- Smooth, positive latching action insured by powerful conical spring.
- Full lip style strike for simplified mortising.
- Face plate 2 1/4" x 7/8"
- Strike 2 1/4" x 1 1/8"
- Lip 1 3/8" to Center
- Bore 3/4" x 1 3/4"
- Includes sheet metal screws.



Price each

Finish	Item	1-9	10-19	20+
Sat. Chr.	333B26D	\$8.80	\$7.92	Call
Brass	333B3	8.80	7.92	Call

Roller Catch 335 Series

- Full lip style strike for simplified mortising.
- Smooth, positive latching action insured by powerful conical spring.
- Nylon roller insures quiet operation.
- Adjustable tension.
- Easily installed on thin doors.
- Strike 2 1/4" x 1 1/8", Lip 1 3/8" to Center
- Face plate 2 1/4" x 7/8"
- Bore 3/4" x 1 3/4"
- Includes sheet metal screws.



Price each

Finish	Item	1-9	10-19	20+
Chrome	335B26	\$10.78	\$9.70	Call
Satin Chr.	335B26D	10.78	9.70	Call
Brass	335B3	10.78	9.70	Call

Roller Catch 336 Series

- Smooth, positive latching action insured by powerful conical spring.
- Durable nylon roller insures quiet operation.
- Adjustable tension.
- Easily installed on thin doors.
- Strike 2 1/4" x 7/8", Lip 1 1/8" to Center
- Face plate 2 1/4" x 7/8"
- Bore 3/4" x 1 3/4"
- Includes sheet metal screws.



Price each

Finish	Item	1-9	10-19	20+
Satin Chr.	336B26D	\$10.78	9.70	Call
Chrome	336B26	10.78	9.70	Call
Brass	336B3	10.78	9.70	Call

Adjustable Ball Catch 345 Series

- Ideal for cabinets and small interior doors.
- Free rolling ball insures smooth, positive and trouble-free action.
- Adjustable threaded barrel compensates for various clearances of doors.
- Strike .1 1/2" x 2 5/32", Lip 1 3/32" to Center
- Face plate 1 1/2" x 3/4"
- Bore 9/16" x 7/8"
- Includes screws.



Price each

Finish	Item	1-9	10-19	20+
Brass	345B3	\$6.86	\$6.17	Call
Chrome	345B26	6.86	6.17	Call
Satin Chr.	345B26D	6.86	6.17	Call

Dual Adjustable Ball Catch 346 Series

- For catch in jamb installations.
- Dual adjustment for door clearance and holding strength.
- Narrow strike is designed for use where strike is mounted in the door.
- Strike 2 1/8" x 1 1/8", Lip 9/16" to Center
- Face plate 2 1/8" x 1"
- Bore 7/8" x 1 1/4"
- Includes screws.



Price each

Finish	Item	1-9	10-19	20+
Chrome	346B26	\$10.08	\$9.07	Call
Satin Chr.	346B26D	10.08	9.07	Call
Brass	346B3	10.08	9.07	Call

Dual Adjustable Ball Catch 347 Series

- For catch in door installations.
- Dual adjustment for door clearance and holding strength.
- Lip strike is especially designed for use where strike is mounted in the jamb.
- Strike 2 1/8" x 1 3/8", Lip 7/8" to Center
- Face plate 2 7/8" x 1"
- Bore 7/8" x 1 1/4"
- Includes screws.



Price each

Finish	Item	1-9	10-19	20+
Chrome	347B26	\$10.08	\$9.07	Call
Satin Chr.	347B26D	10.08	9.07	Call
Brass	347B3	10.08	9.07	Call

Friction Casement Adjuster

- Packaged with screws.
- Securely holds casement window in any position.
- Friction construction allows flexible positions without manual adjustment.
- Can also be used to hold cabinet lids in various adjustable positions.
- Projection 1", 15-20 lbs of friction.
- Tube $\frac{3}{8}$ " x $\frac{5}{8}$ "



Finish	L.	Max. Open.	Item	Price each	
				1-19	20+
Brass	10"	105"	287B3-10	\$41.22	\$38.54
Sat. Chr.	12"	110"	287B26D-12	48.62	45.46

Friction Casement Adjuster

- Packaged with screws.
- Securely holds casement window in any position.
- Friction construction allows flexible positions without manual adjustment.
- Features positive locking.
- Can be used to adjust cabinet lids and drafting table tops.
- Projection 1", Maximum opening: 105°
- Tube $\frac{3}{8}$ " x $\frac{5}{8}$ "



Finish	L.	Lbs. of Fric.	Item	Price each	
				1-19	20+
Brass	10"	15	288B3-10	\$56.08	\$52.43

Floor Door Stop

- 1" high
- For doors without threshold.
- Gray, non-marring rubber bumper.
- Includes wood screw and plastic anchor.



Finish	Item	Price each	
		1-29	30+
Chrome	436B26	\$5.67	Call
Satin Chr.	436B26D	5.67	Call
Brass	436B3	5.67	Call
Sat. Brass	436B4	5.67	Call
Sat. Alum	436PA28	5.67	Call

Wall Door Stop

- 1" diameter. $\frac{9}{16}$ " projection.
- Compact size.
- Concealed mounting.
- Convex gray rubber bumper
- Includes: Sheet metal screws, Rawl plug, Brads.



Finish	Item	Price each	
		1-19	20+
Chrome	404B26	\$4.95	Call
Satin Chr.	404B26D	4.95	Call
Brass	404B3	4.95	Call

Concave Wall Door Stop with Plastic Anchor

- $2\frac{7}{16}$ " diameter. $\frac{15}{16}$ " projection.
- Concave rubber permits knob to strike stop without damaging or engaging lock mechanism.
- Factory assembled backplate.
- Concealed mounting.
- Includes wood screw and plastic anchor.
- Easy installation by inserting screw through small hole in rubber.

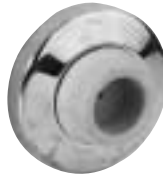

Finish	Item	Price each	
		1-19	20+
Chrome	406-1/2B26	\$4.41	Call

Convex Wall Door Stop with Plastic Drywall Anchor

- $2\frac{7}{16}$ " diameter. $\frac{15}{16}$ " projection.
- Factory assembled backplate.
- Concealed mounting.
- Includes plastic drywall anchor and screw.
- Easy installation by inserting screw through small hole in rubber.



Finish	Item	Price each	
		1-19	20+
Chrome	407B26	\$4.41	Call
Satin Chr.	407B26D	4.41	Call
Brass	407B3	4.41	Call

Concave Wall Door Stop with Plastic Drywall Anchor

- $2\frac{7}{16}$ " diameter. $\frac{15}{16}$ " projection.
- Includes plastic drywall anchor and screw.
- Concave rubber permits knob to strike stop without damaging or engaging lock mechanism.
- Easy installation by inserting screw through small hole in rubber.
- Factory assembled backplate.
- Concealed mounting.



Finish	Item	Price each	
		1-19	20+
Brass	407-1/2B3	\$4.41	Call
Brass	407-1/2B26D	4.41	Call

Riser for use with door stop 436

- $\frac{5}{8}$ " high
- For conversion of floor door stops to carpet installation.
- Includes #14 x $2\frac{1}{4}$ " F.H. wood screws, lead shield and $\frac{1}{4}$ " dia. long stud.



Height	Item	Price each	
		1-19	20+
$\frac{1}{4}$ "	435A-1/4"	\$4.55	Call
$\frac{1}{2}$ "	435A-1/2"	4.55	Call
1"	435A-1"	4.55	Call

Floor Door Stop

- $1\frac{3}{8}$ " high
- For doors with threshold or undercut doors.
- Gray, nonmarring rubber bumper.
- Includes wood screw and plastic anchor.



Finish	Item	Price each	
		1-19	20+
Chrome	438B26	\$5.95	Call
Satin Chr.	438B26D	5.95	Call
Brass	438B3	5.95	Call
Sat. Brass	438B4	5.95	Call
Sat. Alum	438PA28	5.95	Call



Heavy Duty Wall Stop & Holder

- Heavy duty for high traffic areas.
- Resilient, nonmarring rubber tip.
- Base dia. 2 1/4" • Projection 3 5/8"
- Includes wood screws.



Finish	Item	Price each	
		1-19	20+
Sat. Chrome	449B26D	\$38.62	Call
Brass	449B3	38.62	Call

Heavy Duty Wall Door Stop



Finish	Item	Price each	
		1-19	20+
Brass	447B3	\$21.14	Call

Heavy Duty Floor Door Stop

- Packed with wood screws.
- Designed for commercial applications.
- Nonmarring rubber tip.
- Accommodates doors undercut up to 2 1/2"
- Base dia. 2 1/2"
- Height 3"



Finish	Item	Price each	
		1-19	20+
Brass	448B3	\$28.37	Call
Sat. Chrome	448B26D	28.37	Call

Door Holder

- Packed with sheet metal screws.
- Rugged construction for commercial applications.
- Door stays open in desired position.
- Replaceable rubber tip.
- Stainless steel spring.
- Foot operated.
- Arm length 4"



Height	Finish	Item	Price each	
			1-19	20+
4"	Satin Chr.	452B26D-4	\$29.64	Call
4"	Brass	452B3-4	29.64	Call
5"	Satin Chr.	452B26D-5	34.82	Call
5"	Brass	452B3-5	34.82	Call

Plunger Type Holder

- Cast bronze body
- Popular hold open mechanism, designed to hold door open in virtually any position.
- Plunger activates with minimal pressure. Releases with light tap
- Non-marring rubber shoe
- 5 3/8" O.A. height plus 1 1/4" throw.



Finish	Item	Price each	
		1-19	20+
Satin Chrome	1154-US26D	\$52.00	Call

Hinge Pin Door Stops

- For use on hinged doors where the installation of a standard door stop is not desirable
- Designed for narrow trim installation.
- Replaceable nonmarring rubber tips.
- Removable bushings accommodate 1/4" to 5/16" diameter hinge-pins.
- Door opening adjustments 85° to 125°
- Easy installation.



Finish	Item	Price each	
		1-19	20+
Nickel	70A14	\$2.39	Call
Brass Plate	70A3	2.39	Call

Heavy Duty Floor Stop & Holder

- Resilient, nonmarring rubber tip.
- Accommodates doors undercut up to 2 1/2"
- Designed for high traffic areas in commercial applications.
- Base dia. 2 1/2"
- Height 3 5/8"
- Includes expansion shield & lead shield.



Finish	Item	Price each	
		1-19	20+
Satin Chr.	446B26D	\$43.71	Call
Brass	446B3	43.71	Call

Heavy Duty Floor Stop & Holder

- Packed with wood screws.
- Designed for high traffic areas in commercial applications.
- Resilient, nonmarring rubber tip.
- Accommodates doors undercut up to 2 1/2"
- Base dia. 2 1/2"
- Height 3 5/8"

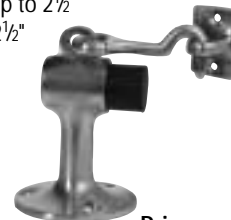

Finish	Item	Price each	
		1-19	20+
Satin Chr.	450B26D	\$44.89	Call
Chrome	450B26	44.89	Call
Pol. Brass	450B3	44.89	Call

Base Door Stops

- One piece with replaceable rubber tip.
- Available in three projection sizes to accommodate varying areas of installation and door trim dimensions



Finish	Proj.	Item	Price each	
			1-19	20+
Brass Plate	3 3/4"	60A3	\$3.27	Call
Nat. Alum.	3 3/4"	60A92	3.27	Call
Chrome	3 3/4"	60MB26	10.59	Call
Satin Chr.	3 3/4"	60MB26D	10.59	Call
Brass Plate	3"	61A3	2.89	Call
Nat. Alum.	3"	61A92	2.89	Call
Chrome	3"	61MB26	6.84	Call
Satin Chr.	3"	61MB26D	6.84	Call
Brass	3"	61MB3	6.84	Call
Nat. Alum.	4 3/4"	62A92	3.90	Call
Satin Chr.	4 3/4"	62MB26D	12.11	Call
Brass	4 3/4"	62MB3	12.11	Call

Base Door Stop

- Replaceable rubber tip.
- Base dia. 1 3/8"
- Projection 3 3/4"
- Includes sheet metal screws.

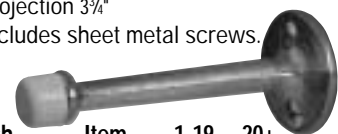

Finish	Item	Price each	
		1-19	20+
Brass Plate	65A3	\$3.27	Call
Nat. Alum.	65A92	3.27	Call

- Check out **Sliding Door Hardware**
- Check out **Fasteners & Cutting Tools**

Traditional Coat & Hat Hook

- All-purpose hook in traditional design.
- Base 1 $\frac{3}{4}$ "H x 1 $\frac{1}{32}$ " W
- Projection 3"
- Includes screws.



Finish	Item	Price each	
		1-19	20+
Nickel Plate	571A14	\$2.99	Call
Brass Plate	571A3	2.99	Call
Dull Chrome	571MB26D	6.88	Call
Brass	571MB3	6.88	Call

Upturn Coat & Hat Hook

- Step-up decorative version of our traditional cast aluminum.
- Ideal for locations where additional strength is required.
- Projection 3 $\frac{1}{2}$ "
- Includes screws.

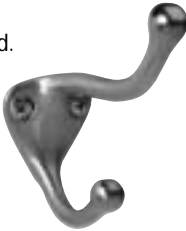

Finish	Item	Price each	
		1-19	20+
Base dimension 1 $\frac{7}{16}$ "H x 1 $\frac{15}{32}$ " W			
Chrome	572MB26	9.50	Call
Satin Chr.	572MB26D	9.50	Call
Brass	572MB3	9.50	Call

Wardrobe Hooks

Double Hook

- Compact hook is perfect where space is limited, ideal for behind doors where low profile is desired.
- Base 1 $\frac{1}{8}$ "H x 1 $\frac{1}{8}$ " W
- Projection 1 $\frac{1}{8}$ "
- Includes screws.



Finish	Item	Price each	
		1-19	20+
Brass Plate	582A3	\$2.99	Call
Nat. Alum.	582A92	2.99	Call
Brass	582MB3	5.46	Call

Wide Body Coat & Hat Hook

- Wide body design withstands rough duty in public buildings, schools & dormitories.
- Base 1 $\frac{1}{2}$ "H x $\frac{7}{8}$ " W
- Projection 2 $\frac{1}{2}$ "
- Includes screws.



Finish	Item	Price each	
		1-19	20+
Nickel	405A14	\$2.99	Call
Brass Plate	405A3	2.99	Call
Nat. Alum.	405A92	2.99	Call

Contemporary Coat & Hat Hook

- Decorative design for commercial and residential installations.
- Base 1 $\frac{5}{8}$ "H x 1 $\frac{3}{4}$ " W
- Height 5"
- Projection 3 $\frac{3}{4}$ "
- Includes screws.



Finish	Item	Price each	
		1-19	20+
Chrome Plated	574A26	\$5.65	Call
Brass Plated	574A3	5.65	Call
Chrome	574B26	22.11	Call
Brass	574B3	22.11	Call

Single Hook

- Compact hook is perfect where space is limited, ideal for behind doors where low profile is desired.
- Base 1 $\frac{1}{8}$ "H x 1 $\frac{1}{8}$ " W
- Projection 1 $\frac{1}{16}$ "
- Includes screws.



Finish	Item	Price each	
		1-19	20+
Brass Plate	581A3	\$2.99	Call
Nat. Alum.	581A92	2.99	Call
Chrome	581MB26	4.62	Call
Satin Chr.	581MB26D	4.62	Call
Solid Brass	581MB3	4.62	Call

Kick Plates & Push Plates

- Beveled four sides unless specified.
- Individually packed with stainless steel sheet metal screws, plated to match finish

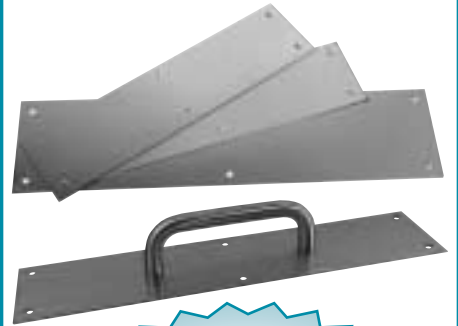

Many sizes and finishes available. Please Inquire.



- Bommer enjoys a reputation as one of the oldest and most proficient manufacturers of Postal Service-approved mailboxes.
- Models carrying the Bommer trademark have become the standard for multiple dwelling units: apartment houses, condominiums, dormitories and other institutional-type facilities.





Hand Rail Bracket For Commercial Applications

- Exceeds OSHA and BHMA strength test requirements
- Base dia. 3
- Base to center of rail: 3 1/8"

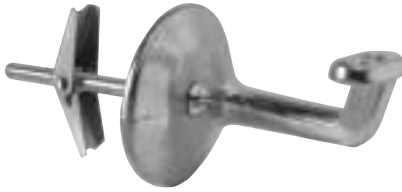

- Includes toggle bolt and screws.

Finish	Item	Price each	
		1-19	20+
Nat. Alum.	158A92	\$9.05	Call
Brass	158A3	9.05	Call



- Includes square head iron lag screw, expansion shield and screws.

Finish	Item	Price each	
		1-19	20+
Brass	159A3	\$11.99	Call

Bar Window Lifts

- Packed with screws.
- Facilitates opening of window in a safe manner.
- Can also be used as drawer or utility pull.
- 5"W x 1 3/8" H. Projection 1 1/4"
- Solid Brass



Finish	Item	Price each	
		1-19	20+
Polished Chr.	27MB26	\$15.28	Call

Window /Table Lock

- Packed with screws.
- Spring actuated lever provides positive direct pull which pulls rails together
- Stops rattles and drafts.
- When unlocking, lever automatically returns to opened position
- Base 1 3/8" x 2 5/16"
- Strike 9/16" x 2 3/16"



Finish	Item	Price each	
		1-19	20+
Brass	4B3	\$10.92	Call

Window Lock

- Packed with screws.
- Designed low to the sash for superior strength and greater resistance to breakage.
- Vertical and horizontal camming action for snug, non-rattling fit.
- Base 1 5/16" x 2 5/8"
- Strike 5/8" x 2 5/8"
- Solid Brass



Finish	Item	Price each	
		1-19	20+
Aluminum	07A92	\$3.68	Call
Brass	07MB3	11.50	Call

Window Lock

- Packed with screws.
- Designed low to the sash for superior strength and greater resistance to breakage.
- Vertical and horizontal camming action for snug, non-rattling fit.
- Heavy gauge springs provide long-wearing action.
- Base 1 1/16" x 3"
- Strike 5/8" x 3"



Finish	Item	Price each	
		1-19	20+
Brass	9MB3	\$20.11	Call

Casement Fasteners

- For use on windows to provide weather tight fastening and security.
- Base 1 5/8" x 7/8"
- Projection 1 3/8"
- Includes mortise strike and screws.

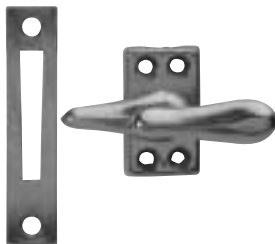

Finish	Item	Price each	
		1-19	20+
Satin Chr.	066B26D	\$21.79	Call
Brass	066B3	21.79	Call

Shutter Bars

- Ideal for bi-fold doors and shutters.
- Shoulder rivet insures easy free swinging bar.
- Rugged construction.
- Base 7/8" x 1 1/2"
- Projection 7/16"
- Includes brass oval head screws.



Finish	Hook Centers	Item	Price each	
			1-19	20+
Brass	1 3/8"	31B3	\$18.26	Call
Pol. Chr.	1 3/8"	31B26	18.26	Call

Transom Catch

- Rugged construction.
- Independent latch action; transom can be closed by pushing directly on ring.
- Reversible; latch bolt can be easily reversed by removing back plate.
- Narrow base for 1 1/4" rail.
- Size 2 1/4" x 1 1/4"
- Latch throw 5/16"
- Includes universal strike and screws.



Finish	Item	Price each	
		1-19	20+
Brass Plate	80A3	\$7.02	Call
Nat. Alum.	80A92	\$7.02	Call